

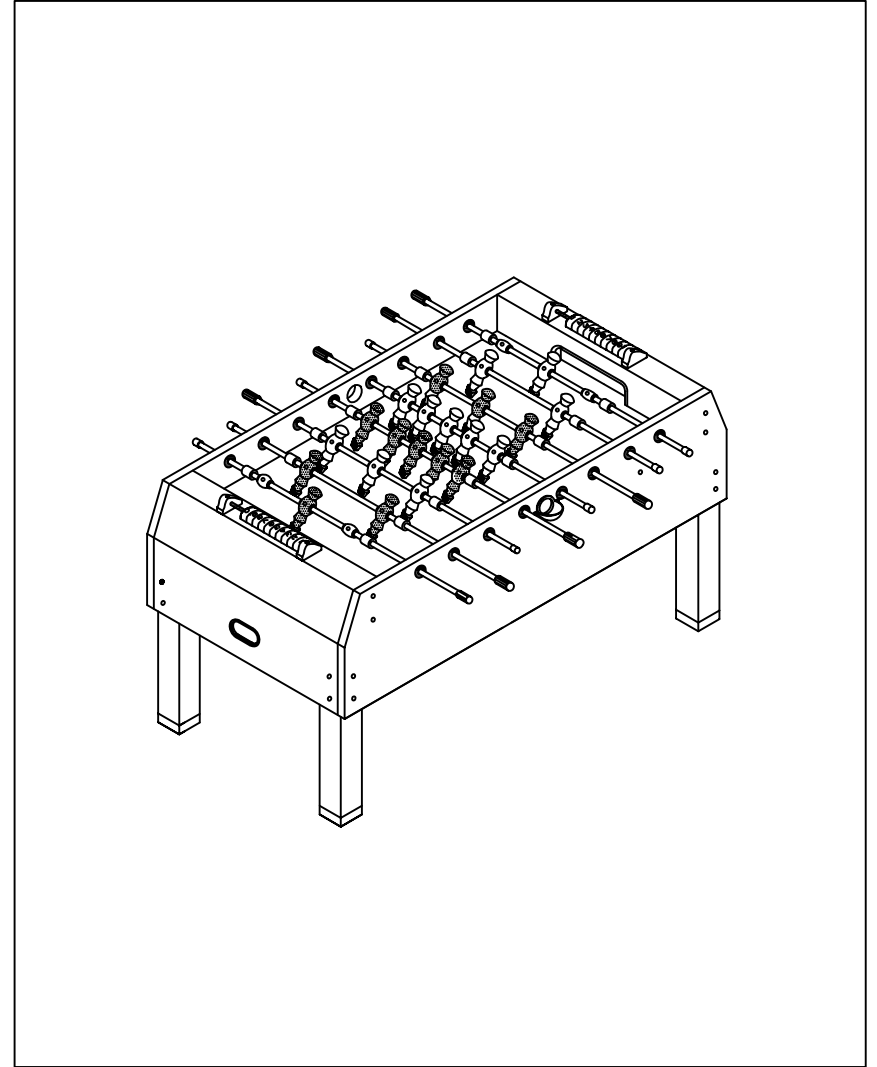

SOCCER TABLE

OWNER'S MANUAL

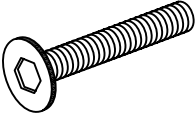

PARTS IDENTIFIER

ASSEMBLY PARTS

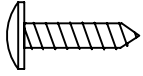
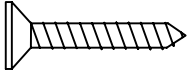
	DESCRIPTION	QTY.
	H1 3/8" x 1-3/4" BOLT	16
	H2 3/8"WASHER	16
	H3 1/2"ROUND HEAD SCREW	6
	H4 1"FLAT HEAD SCREW	4

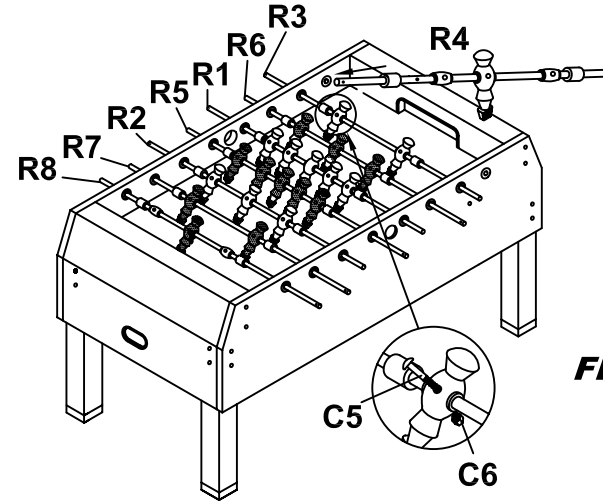
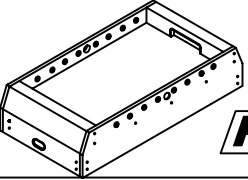
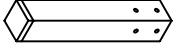
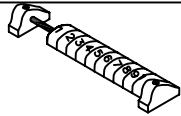

FIGURE 2

- Put rod handles **P4** into the players rods that has a hole at the end by knocking them in .
- Put rod end caps **P5** into the other ends.
- Locate the two sets of slide scores **P3** using four 1"flat head phillips screws **H4** .
- Attach the ball entry cup **P6** to the side panel with screws **H3**.

PARTS IDENTIFIER

ASSEMBLY PARTS

	DESCRIPTION	QTY.
	P1 MAIN	1
	P2 LEG	4
	P3 SLIDE SCORER	2

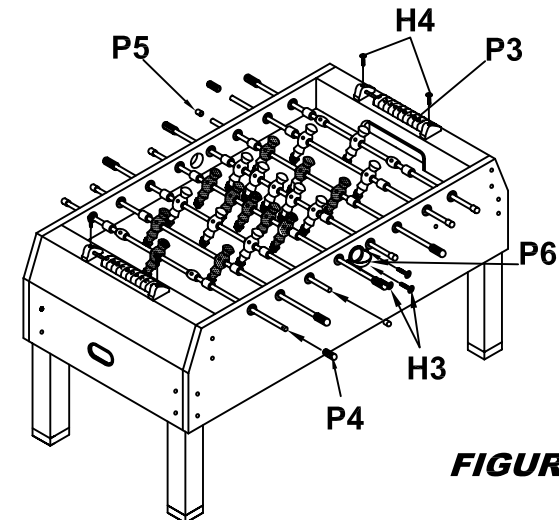

FIGURE 3

ASSEMBLY INSTRUCTIONS

SOCCER TABLE ASSEMBLY

WARNING: TWO ADULTS NEEDED TO ASSEMBLE SOCCER TABLE

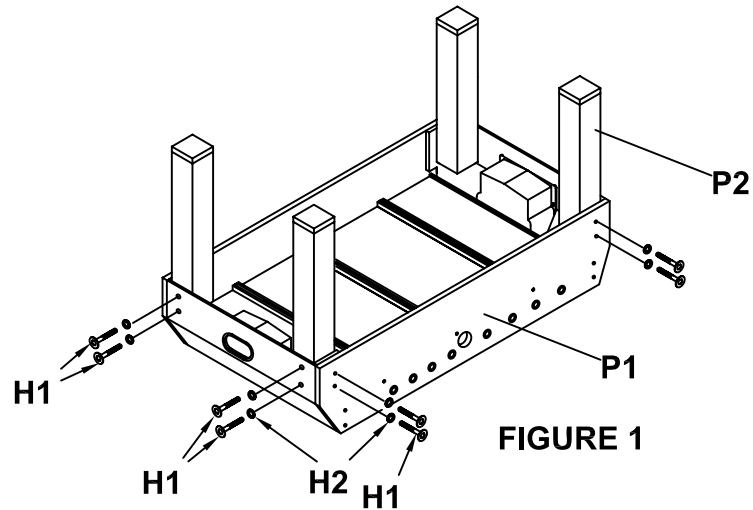

1 Assemble each leg **P2** by using 3/8"x1-3/4"bolts **H1** and 3/8"flat black washers **H2**. Make connections finger tight.



- 2 As shown in **figure 2**, insert the 1 home player rod **R4** through the hole of the two side panels from the inside to the outside in power.
- 3 Assemble the player by using 5/32"x1-1/8"bolt **C5** and lock nut **C6** through the hole in the rod.
- 4 Same parts and order as above assemble one 3 away players rod **R6** , one 2 home players rod **R3**,one 2 away players rod **R7**, one 5 home players rod **R1**, one 5 away players rod **R5**, and 3 home players rod **R2**, another 1 away player rod **R8**.

PARTS IDENTIFIER

ASSEMBLY PARTS

	DESCRIPTION	QTY.
	P4 ROD HANDLE	8
	P5 ROD END CAP	8
	P6 BALL ENTRY CUP	2

PARTS IDENTIFIER

ASSEMBLY PARTS

	DESCRIPTION	QTY.
	A1 SOCCER BALL	2
	A2 TOOL	2

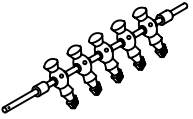
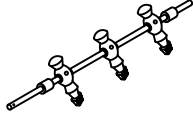
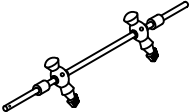

PARTS IDENTIFIER

ASSEMBLY PARTS

	DESCRIPTION	QTY.
	R1 5 HOME PLAYERS ROD	1
	R2 3 HOME PLAYERS ROD	1
	R3 2 HOME PLAYERS ROD	1

PARTS IDENTIFIER

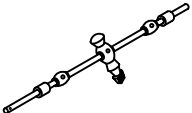
ASSEMBLY PARTS

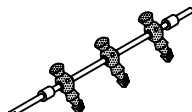
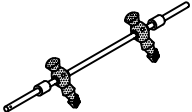
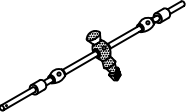
	DESCRIPTION	QTY.
	R4 1 HOME PLAYER ROD	1
	R5 5 AWAY PLAYERS ROD	1
	R6 3 AWAY PLAYERS ROD	1
	R7 2 AWAY PLAYERS ROD	1
	R8 1 AWAY PLAYER ROD	1





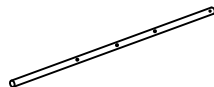
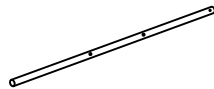
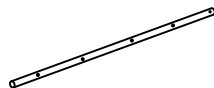

PARTS IDENTIFIER

ASSEMBLY PARTS

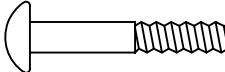
	DESCRIPTION	QTY.
	C1 3 PLAYER ROD	4
	C2 2 PLAYER ROD	2
	C3 5 PLAYER ROD	2

PARTS IDENTIFIER

ASSEMBLY PARTS

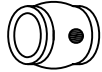
	DESCRIPTION	QTY.
	C4 RUBBER BUSHING	16
	C5 5/32"x1-1/8" BOLT (used to install men)	26
	C6 LOCK NUT (used to install men)	26
	C7 PLASTIC ROD WASHER	32
	C8 HOME MEN	11
	C9 AWAY MEN	11
	C10 ROD BUSHING	32
	C11 STOP RING	4